

KOVA T Tunnel Lighting

Kova T Tunnel Lighting

IP66 | IK10 | CLASS I

Features:

Vandal-proof design

Highly efficient, save up to 65% energy over fluorescent alternatives

Access using a key

Light source:

LED module: LED modules

Colour temperature: 4000K

Colour rendering index: >70Ra

Optical control:

Asymmetric / Symmetric / Square / Wide

Light output:

Version	Power Consumption	Lumen Output (lm)	Efficacy (lm/W)	Max. Ambient Temperature
30	31.1W	5340	172	50°C
40	42.3W	7382	175	50°C
50	49.2W	8610	175	50°C
70	64.4W	11203	174	50°C
90	84.5W	14450	171	50°C
110	107.5W	17906	167	50°C
130	121.5W	20898	172	50°C
170	149.2W	25447	171	50°C
250	201.5W	32821	163	50°C
270	239.0W	40869	171	50°C
300	285.5W	47393	166	50°C
330	337.0W	54257	161	50°C
360	350.2W	58311	167	50°C
400	397.6W	64013	161	50°C

L90 (B10) lifetime prediction:

In excess of 100,000 hours

Switching and control:

Dimmable: DALI

Colours:

Grey

Materials:

Body: Stainless Steel

Diffuser: Tempered Glass

Image:

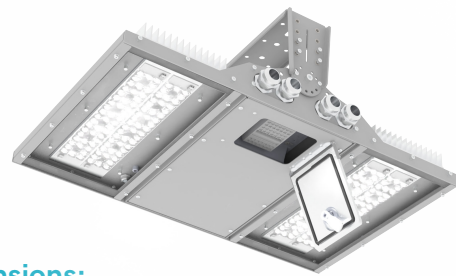

Dimensions:

VERSIONS 30, 40, 50, 70, 90, 110

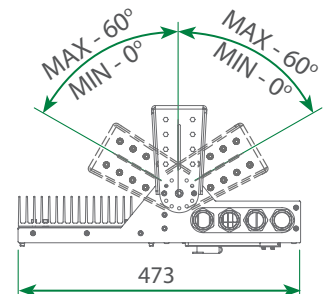
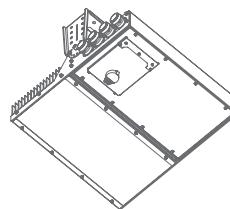

VERSIONS 130, 170, 250, 270, 300, 330, 360, 400

682 - for versions 360 i 400
470 - for versions 130, 170, 250
562 - for versions 270, 300, 330

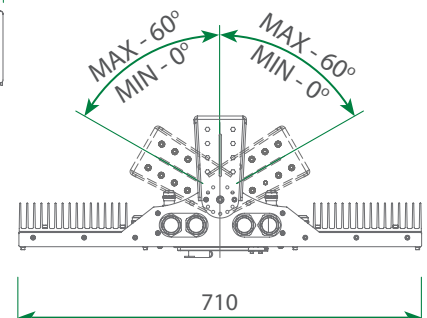
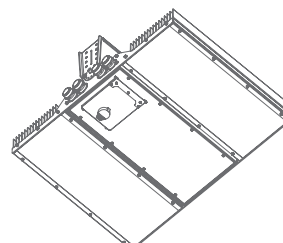

Kova T Tunnel Lighting

Product code configurator

example: **KOT110HB47PT10M25316GL**

Product range

Kova T **KOT**

Power

030 - 30W	110 - 110W	300 - 300W
040 - 40W	130 - 130W	330 - 330W
050 - 50W	170 - 170W	360 - 360W
070 - 70W	250 - 250W	400 - 400W
090 - 90W	270 - 70W	

Module Type

HB4 - 30W,40W,50W,70W,90W,110W

HB8 - 130W,170W,250W,270W,300W,330W

HB10 - 360W,400W

Wiring

3 Pole Terminal	3PT
4 Pole Terminal	4PT
5 Pole Terminal	5PT
6 Pole Terminal	6PT
7 Pole Terminal	7PT

Cable Inlets - Quantity

1 Inlets	10
2 Inlets	20
3 Inlets	30
4 Inlets	40

Cable Inlets - Material

Metal	M
Plastic	P

Cable Inlets - Size

M20	20
M25	25
M32 (available for 10 & 20)	32

Housing Materials

Steel Type ST304	304
Steel Type ST316	316
Steel Type ST316 Ti	STI

Diffuser Materials

Tempered Glass	GL
----------------	----

Bracket Dimensions

VERSIONS 30, 40, 50, 70, 90, 110

STANDARD BRACKET

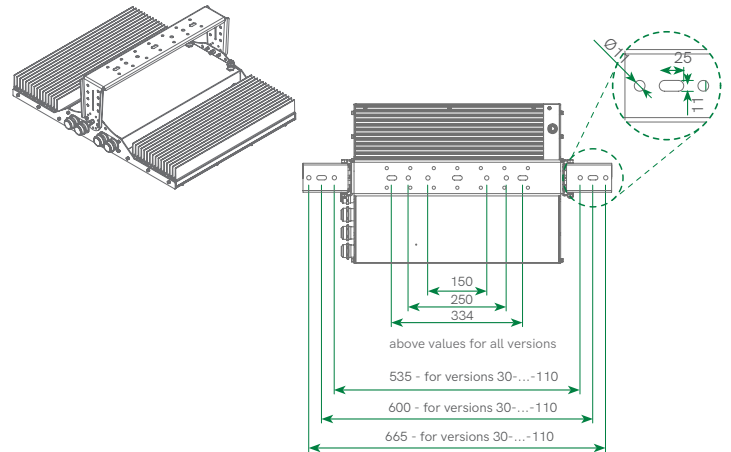

VERSIONS 130, 170, 250, 270, 330, 330, 360, 400

OPTIONAL BRACKET WITH SUPPORT

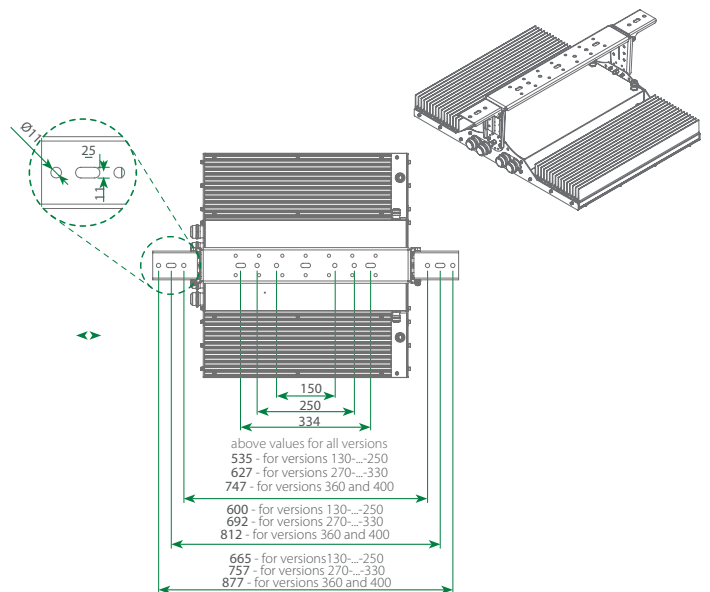

DW Windsor

Pindar Road, Hoddesdon, Hertfordshire, EN11 0DX

T: +44(0) 1992 474600 | E: info@dw Windsor.com

dw Windsor.com



September 2021



FM 53278 EMS 562929 OHS 562930



DW Windsor is part of the Luceco Group