

Product Name	Pharola Max 2
Mounting Options	Root mounted / Flange plate
Output	up to 1,560lm
Light Source	LED
Colour Temp	2700K / 3000K / 4000K
CRI	70
Distribution	Symmetric / 180° Backshield (on request)
Number of LEDs	9
Power	20W
Luminaire Efficacy (max)	78lm/W
Electrical Class	Class I (II on request)
Operating Voltage	220-240V
Driver	Tridonic
Drive Current Range	700mA
Lifetime	100,000 (L70)
Operating Temperature	-40° to 40°C
IP Rating	IP66
IK Rating	IK10
Colour Finish	White RAL 9016 / Black RAL 9005 / Aluminium RAL 9006 / Metallic Grey 9007 / Metallic Dark Grey DB703 / Other RAL colours on request
Housing Material	Galvanised steel (body), die-cast aluminium (head)
Finish	Polyester powder coat
Glazing Material	Polycarbonate
Weight	18kg
Certifications	CE
Control Options	Remote switch

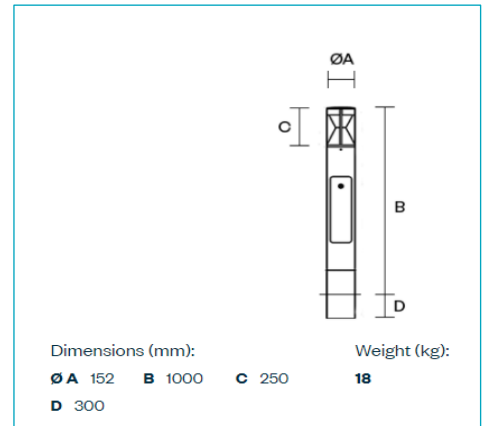

Additional Information

3000mm height also available.