

SANDY

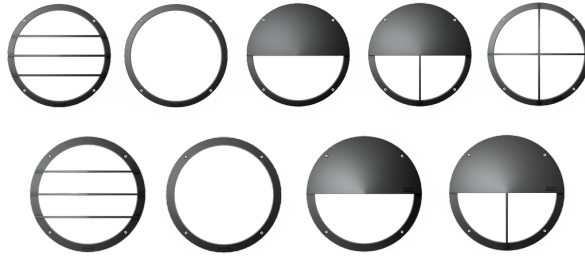

Shielded, circular wall-mounted bulkhead range. Traditional circular exterior family with many attractive grill and shield options.



Luminaire Structure

- Die-cast aluminium housing and frame
- Pre-treated before powder coating ensuring high corrosion resistance
- Two cable entries for through wiring
- Stainless steel fasteners in grade 304 with zinc flake coating (ZFC)
- Durable silicone rubber gasket
- Opal UV-stabilised polycarbonate diffuser
- Integral control gear
- Optional surface mounting box for easy wiring or conduit connection when wiring from behind is not possible

Feature

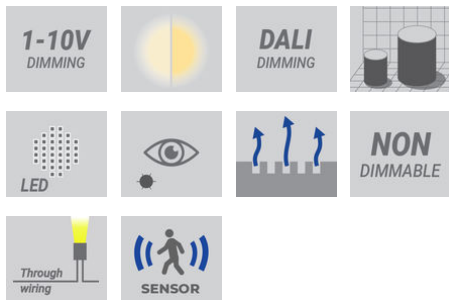

Light symbol

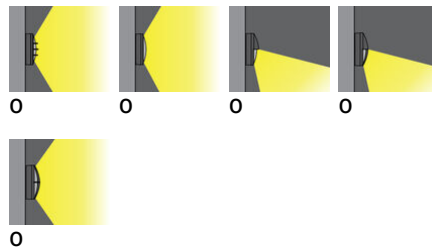

Product colour

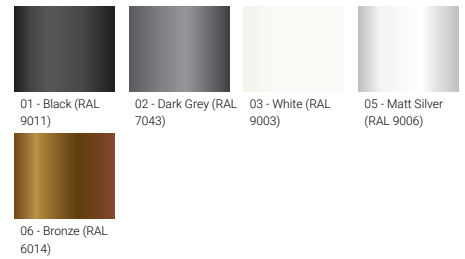

Special finishes upon request

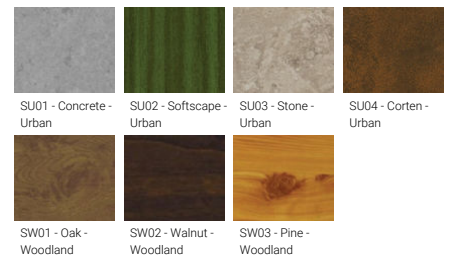

SANDY

Technical information

	Model number	Light source	Power	Lumen	Optic	CCT / CRI	Dimming type	Weight
Large								
SANDY 7	SA-31532	96 LED	27 W	2170 - 2284 lm	O [114°x102°]	3000K CRI80, 4000K CRI80	DALI, 1-10V, On/Off	4.0 kg
SANDY 8	SA-31542	96 LED	27 W	2355 - 2478 lm	O [115°x114°]	3000K CRI80, 4000K CRI80	DALI, 1-10V, On/Off	3.8 kg
SANDY 9	SA-31552	96 LED	27 W	1250 - 1315 lm	O [115°x119°]	3000K CRI80, 4000K CRI80	DALI, 1-10V, On/Off	4.1 kg
SANDY 10	SA-31562	96 LED	27 W	1211 - 1275 lm	O [110°x109°]	3000K CRI80, 4000K CRI80	DALI, 1-10V, On/Off	4.1 kg
Large - TW								
SANDY 7	SA-31533	192 LED	28 W	2044 lm	O [114°x103°]	TW (2700K - 6500K)	DALI	4.0 kg
SANDY 8	SA-31543	192 LED	28 W	2223 lm	O [114°x114°]	TW (2700K - 6500K)	DALI	4.2 kg
SANDY 9	SA-31553	192 LED	28 W	1181 lm	O [109°x119°]	TW (2700K - 6500K)	DALI	4.3 kg
SANDY 10	SA-31563	192 LED	28 W	1149 lm	O [109°x114°]	TW (2700K - 6500K)	DALI	4.3 kg
Large - With integrated motion sensor								
SANDY 7	SA-31532-1MS	96 LED	27 W	2170 - 2284 lm	O [114°x102°]	3000K CRI80, 4000K CRI80	1-10V, On/Off	4.0 kg
SANDY 8	SA-31542-1MS	96 LED	27 W	2355 - 2478 lm	O [115°x114°]	3000K CRI80, 4000K CRI80	1-10V, On/Off	3.8 kg
SANDY 9	SA-31552-1MS	96 LED	27 W	1250 - 1315 lm	O [115°x119°]	3000K CRI80, 4000K CRI80	1-10V, On/Off	4.1 kg
SANDY 10	SA-31562-1MS	96 LED	27 W	1211 - 1275 lm	O [110°x109°]	3000K CRI80, 4000K CRI80	1-10V, On/Off	4.1 kg
Small								
SANDY 1	SA-31471	80 LED	19 W	1588 - 1671 lm	O [114°x97°]	3000K CRI80, 4000K CRI80	DALI, 1-10V, On/Off	2.1 kg
SANDY 2	SA-31481	80 LED	19 W	1710 - 1800 lm	O [114°x113°]	3000K CRI80, 4000K CRI80	DALI, 1-10V, On/Off	2.0 kg
SANDY 3	SA-31491	80 LED	19 W	902 - 949 lm	O [114°x107°]	3000K CRI80, 4000K CRI80	DALI, 1-10V, On/Off	2.3 kg
SANDY 4	SA-31501	80 LED	19 W	873 - 920 lm	O [107°x107°]	3000K CRI80, 4000K CRI80	DALI, 1-10V, On/Off	2.3 kg
SANDY 6	SA-31521	80 LED	19 W	1602 - 1686 lm	O [108°x108°]	3000K CRI80, 4000K CRI80	DALI, 1-10V, On/Off	2.1 kg
Small - TW								
SANDY 1	SA-31472	160 LED	20 W	1535 lm	O [113°x102°]	TW (2700K - 6500K)	DALI	2.1 kg
SANDY 2	SA-31482	160 LED	20 W	1685 lm	O [113°x113°]	TW (2700K - 6500K)	DALI	2.2 kg
SANDY 3	SA-31492	160 LED	20 W	867 lm	O [107°x116°]	TW (2700K - 6500K)	DALI	2.3 kg
SANDY 4	SA-31502	160 LED	19 W	836 lm	O [107°x113°]	TW (2700K - 6500K)	DALI	2.3 kg
SANDY 6	SA-31522	160 LED	20 W	1583 lm	O [109°x109°]	TW (2700K - 6500K)	DALI	2.4 kg
Small - With integrated motion sensor								
SANDY 1	SA-31471-1MS	80 LED	19 W	1588 - 1671 lm	O [114°x97°]	3000K CRI80, 4000K CRI80	1-10V, On/Off	2.1 kg
SANDY 2	SA-31481-1MS	80 LED	19 W	1710 - 1800 lm	O [114°x113°]	3000K CRI80, 4000K CRI80	1-10V, On/Off	2.0 kg
SANDY 3	SA-31491-1MS	80 LED	19 W	902 - 949 lm	O [114°x107°]	3000K CRI80, 4000K CRI80	1-10V, On/Off	2.3 kg
SANDY 4	SA-31501-1MS	80 LED	19 W	873 - 920 lm	O [107°x107°]	3000K CRI80, 4000K CRI80	1-10V, On/Off	2.3 kg
SANDY 6	SA-31521-1MS	80 LED	19 W	1602 - 1686 lm	O [108°x108°]	3000K CRI80, 4000K CRI80	1-10V, On/Off	2.1 kg

Accessories

We reserve the right to make technical and design changes.







01:21, 30-01-2023





<https://www.ligman.com/sandy-surface-facade-luminaires-sa-su3/>

THAILAND
LIGMAN Lighting Co.,Ltd.
17/2 Moo 4, Monthong, Bang Nam Preaw,
24150 Chachoengsao - Thailand
info@ligman.com

INDIA
LIGMAN India Illumination Systems Private Ltd.
D-35, EPIP Site V, Kasna Industrial Estate,
Gautam Budh Nagar, U.P. 201306 Greater Noida - India
sales.in@ligman.com

SANDY

	 Remote controller for the motion sensor - 0-10V (A34191) A34391	 DALI Control System Control-DALI	 Surface mounting box for easy cabling (SANDY 1) SCE-SANDY-1	 Surface mounting box for easy cabling (SANDY 10) SCE-SANDY-10	 Surface mounting box for easy cabling (SANDY 2) SCE-SANDY-2	 Surface mounting box for easy cabling (SANDY 3) SCE-SANDY-3	 Surface mounting box for easy cabling (SANDY 4) SCE-SANDY-4
SA-31471		•	•				
SA-31471-1MS	•	•	•				
SA-31472			•				
SA-31481		•			•		
SA-31481-1MS	•	•			•		
SA-31482					•		
SA-31491		•				•	
SA-31491-1MS	•	•				•	
SA-31492						•	
SA-31501		•					•
SA-31501-1MS	•	•					•
SA-31502							•
SA-31521		•					
SA-31521-1MS	•	•					
SA-31522							
SA-31532		•					
SA-31532-1MS	•	•					
SA-31533							
SA-31542		•					
SA-31542-1MS	•	•					
SA-31543							
SA-31552		•					
SA-31552-1MS	•	•					
SA-31553							
SA-31562		•		•			
SA-31562-1MS	•	•		•			
SA-31563				•			

	 Surface mounting box for easy cabling (SANDY 6) SCE-SANDY-6	 Surface mounting box for easy cabling (SANDY 7) SCE-SANDY-7	 Surface mounting box for easy cabling (SANDY 8) SCE-SANDY-8	 Surface mounting box for easy cabling (SANDY 9) SCE-SANDY-9
SA-31471				
SA-31471-1MS				
SA-31472				
SA-31481				
SA-31481-1MS				
SA-31482				
SA-31491				
SA-31491-1MS				
SA-31492				
SA-31501				
SA-31501-1MS				
SA-31502				
SA-31521	•			
SA-31521-1MS	•			
SA-31522	•			
SA-31532		•		
SA-31532-1MS		•		
SA-31533	•			
SA-31542			•	
SA-31542-1MS			•	
SA-31543			•	

We reserve the right to make technical and design changes.

01:21, 30-01-2023

<https://www.ligman.com/sandy-surface-facade-luminaires-sa-su3/>

THAILAND

LIGMAN Lighting Co.,Ltd.
17/2 Moo 4, Monthong, Bang Nam Prew,
24150 Chachoengsao - Thailand
info@ligman.com

INDIA

LIGMAN India Illumination Systems Private Ltd.
D-35, EPIP Site V, Kasna Industrial Estate,
Gautam Budh Nagar, U.P. 201306 Greater Noida - India
sales.in@ligman.com

SANDY

SA-31552	•
SA-31552-1MS	•
SA-31553	•
SA-31562	
SA-31562-1MS	
SA-31563	

THAILAND

LIGMAN Lighting Co.,Ltd.
17/2 Moo 4, Monthong, Bang Nam Preaw,
24150 Chachoengsao - Thailand
info@ligman.com

INDIA

LIGMAN India Illumination Systems Private Ltd.
D-35, EPIP Site V, Kasna Industrial Estate,
Gautam Budh Nagar, U.P. 201306 Greater Noida - India
sales.in@ligman.com

SANDY

SANDY

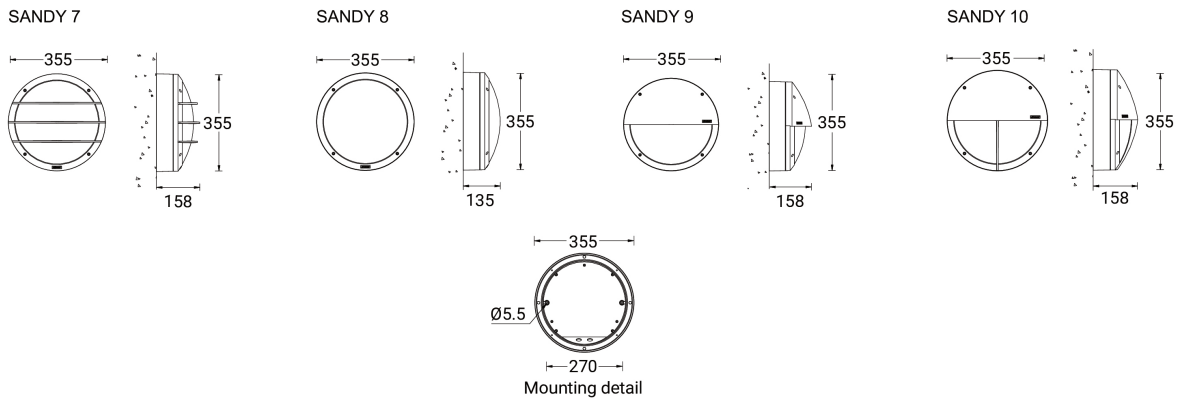
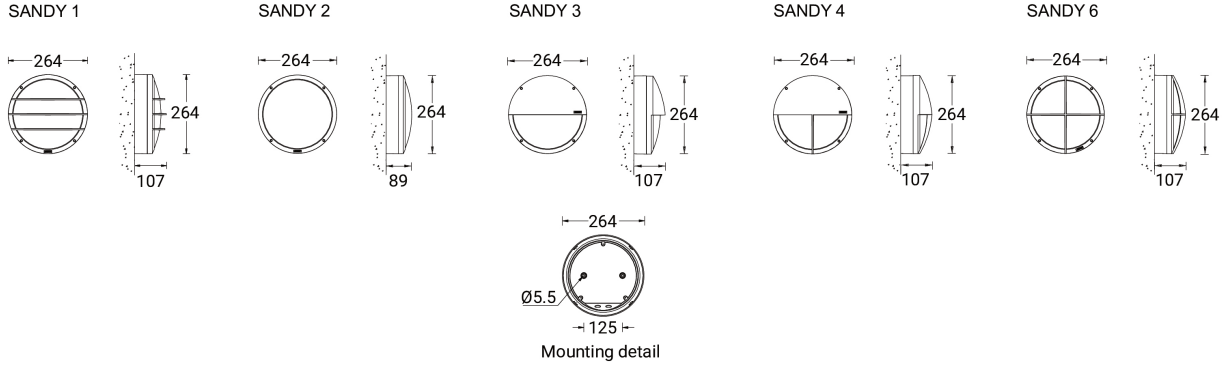

SANDY

Motion sensor - Microwave - 0-10 V

Adjustable sensor (10 seconds – 15 minutes)
150° Sensitivity
Sensor detection area: 8 m

Motion sensor - Microwave - On/Off

Adjustable sensor (5 seconds – 30 minutes)
120° Sensitivity
Sensor detection area: 8 m

