

Installation Instructions

! IMPORTANT

- DISCONNECT ELECTRICAL SUPPLY BEFORE INSTALLATION OR SERVICING.
- THIS PRODUCT MUST BE EARTHED.
- THIS PRODUCT IS DESIGNED TO OPERATE OUTDOORS. IF REQUIRED TO BE USED INDOORS PLEASE CONSULT DW WINDSOR.
- THE LIGHT SOURCE FITTED IN THIS LUMINAIRE SHALL ONLY BE REPLACED BY DW WINDSOR
- DO NOT LOOK DIRECTLY AT LED LIGHT SOURCE.

IP66 IK10



230VAC 50Hz

Product Details

Variant	Dimensions (mm)			Weight (kg)
	A	B	C	
PM1 Flange Plate	900	152	-	17
	3000	152	-	32
PM2 Flange Plate	1000	152	-	18
	3000	152	-	33
PM1 Root Mounted	900	152	300	17
	3000	152	500	32
PM2 Root Mounted	1000	152	300	18
	3000	152	500	33

Mounting Options

Mounting Options	Fig.
Flange Plate	2
Root Mounted	3

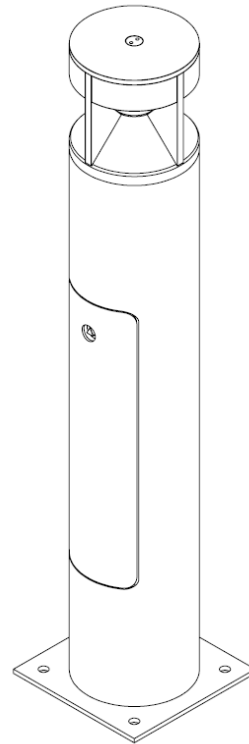

Fig. 2 - Pharola Max 1 Flange Plate

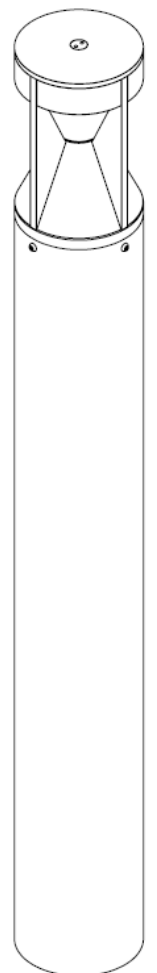

Fig. 3 - Pharola Max 2 Root Mounted

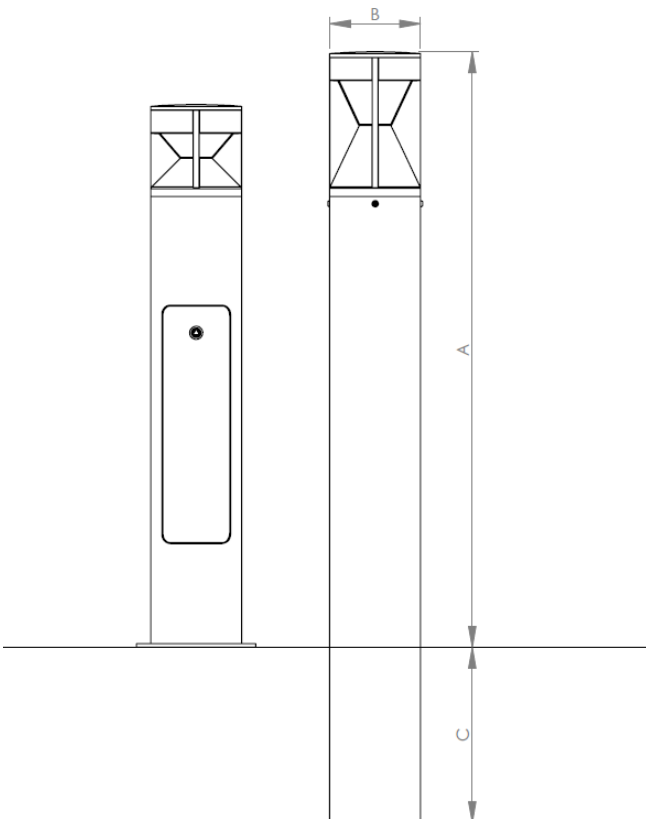

Fig. 1 - Pharola Max Range

Due to continuous product development the details within this document are subject to change at any time, please contact us for the most up-to-date information or visit: www.dwwindsor.com

DW Windsor
Pindar Road, Hoddesdon, Hertfordshire, EN11 0DX
T: +44 (0) 1992 474600 | E: info@dwwindsor.com
www.dwwindsor.com

Pharola Max Bollard Installation Steps | Flange Plate

Step 1

Assemble the bollard base directly to the foundations using the four fixing holes on the flange plate. Check orientation of head and secure base with M12 anchor bolts.

Mains supply cable must enter bollard from below. Ensure there is enough mains cable protruding from the top of the bollard for fitment of the LED head unit.

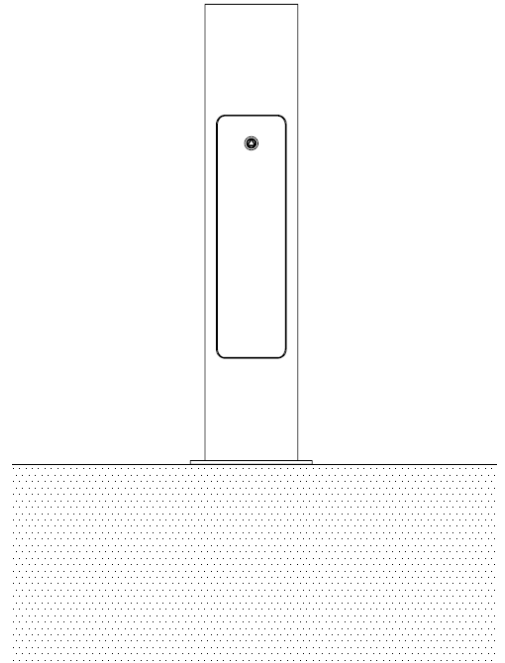

Pharola Max Bollard Installation Steps | Root Mount

Step 1

Install the bollard in the ground observing the correct bollard height and head orientation.

Mains supply cable must enter bollard from below. Ensure there is enough mains cable protruding from the top of the bollard for fitment of the LED head unit.

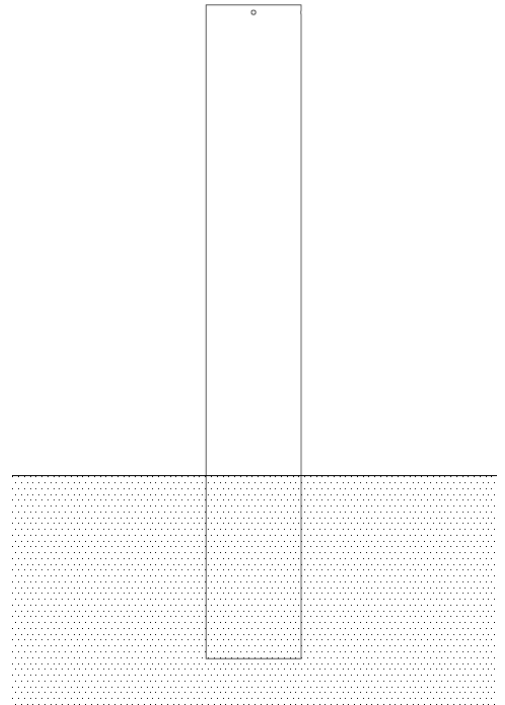

NOTE!

LEDs contained within this luminaire shall only be replaced by the manufacturer, their service agent or similar qualified person.



DW Windsor

Pindar Road, Hoddesdon, Hertfordshire, EN11 0DX
T: +44 (0)1992 474600 | E: info@dw Windsor.com
www.dwwindsor.com

Pharola Max Luminaire Installation Steps | Concealed Fixings

Step 1
Turn off mains power.

Step 2
Drop the luminaire into the bollard and rotate to achieve engagement in the keyhole slots on the inside ring.

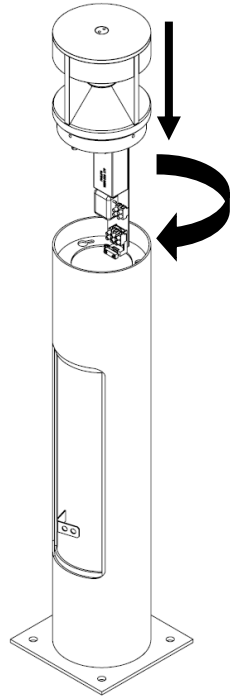

Step 3
Reach through the door opening and tighten to 10Nm the 3x M5 fixings holding the luminaire to the ring with keyhole slots inside the bollard.

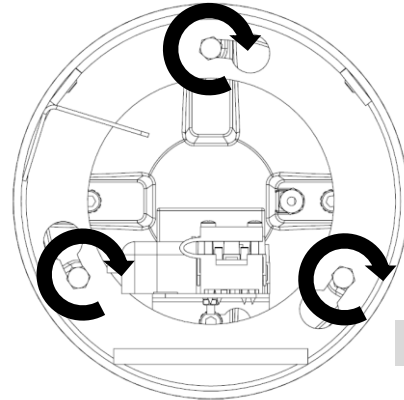

10Nm

Step 4
Wire the electrical supply cable to the terminal block on the gear tray.

IMPORTANT WIRING CODE
L=LIVE (BROWN), N=NEUTRAL (BLUE),
E=EARTH (YELLOW & GREEN)

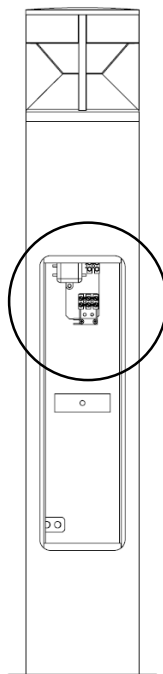

Step 5
Fit the door to the bollard and restore mains power.

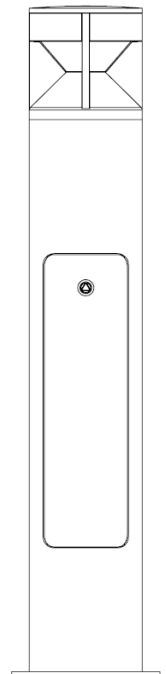

NOTE!

LEDs contained within this luminaire shall only be replaced by the manufacturer, their service agent or similar qualified person.



DW Windsor

Pindar Road, Hoddesdon, Hertfordshire, EN11 0DX
T: +44 (0)1992 474600 | E: info@dw Windsor.com
www.dw Windsor.com

Pharola Max Luminaire Installation Steps | Visible Fixings

Step 1
Turn off mains power.

Step 2
Wire the electrical supply cable to the terminal block on the gear tray.

IMPORTANT WIRING CODE
L=LIVE (BROWN), N=NEUTRAL (BLUE),
E=EARTH (YELLOW & GREEN)

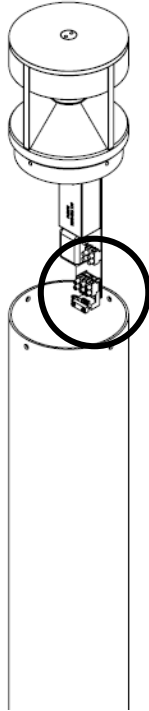

Step 3
Drop the luminaire into the bollard and align the fixing holes.

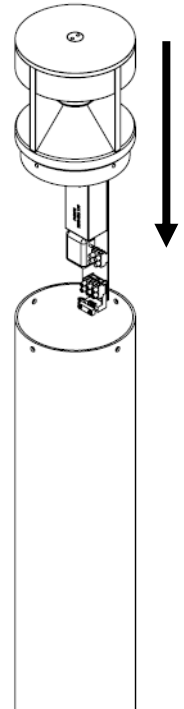

Step 4
Secure the luminaire in place with the 4x M6 Fixings, tighten to 10Nm.

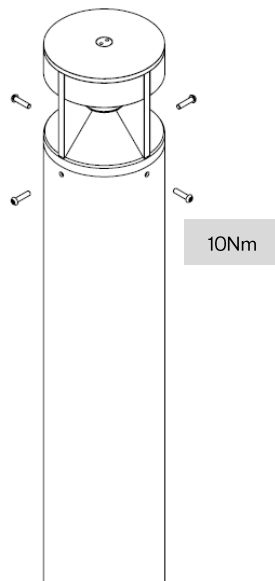

Step 5
Restore mains power.

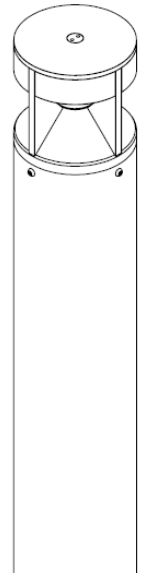

NOTE!

LEDs contained within this luminaire shall only be replaced by the manufacturer, their service agent or similar qualified person.



DW Windsor

Pindar Road, Hoddesdon, Hertfordshire, EN11 0DX
T: +44 (0)1992 474600 | E: info@dw Windsor.com
www.dwwindsor.com