

LuxEOS Flood 36 VIVID COLOUR & TUNABLE WHITE LED FLOOD FOR ARCHITECTURAL LIGHTING



A high performance internally mixed 4 colour LED floodlight using Red, Green, Blue, (Amber or White) **(CRI90+)** LEDs.

KEY FEATURES



LED COLOUR OPTIONS



FINISH OPTIONS



LIGHT QUALITY BEST IN CLASS

Calling upon our 45+ years of lighting expertise, our custom light engines deliver vibrant, internally mixed colour, smooth dimming and exceptional light output.

HIGH PERFORMANCE

Flicker Free

100,000 hours L70 at 50°C

Single bin selected LED's for colour consistency.

TRUE THERMAL DESIGN

Convection cooled for completely silent operation

Intelligent thermal management

Precision engineered housing.

DURABLE AND RELIABLE

Waterproof to IP66 with an IK10 rating

Cast LM6 aluminium housing

Corrosion resistant as standard

Toughened glass & marine grade fasteners.

CUSTOMISE TO YOUR SPECIFICATION

RAL paint finishes

Bespoke mounting brackets

Comprehensive range of beam angles are available









Single colour options.

UK DESIGN & MANUFACTURE

The LuxEOS range of products are all designed and manufactured in **Hertfordshire, UK.**

LuxEOS Flood 36 VIVID COLOUR & TUNABLE WHITE

LED FLOOD FOR ARCHITECTURAL LIGHTING

Options	Light Engine	LED Type	 Quad VC RGBW 5700K	 Quad VC RGBW 2700K	 Quad VC RGBA 1700K	 TW A 1700K W 2700K C 5700K	 Custom
		No. of LED's	144	144	144	144	On enquiry
		CRI	90+ (white)	90+ (white)	-	90+ (CW)	On enquiry
		Wavelength CCT (Colour Temp K)	R 624 - 634nm G 525 - 530nm B 445 - 450nm Cool W - 5700K	R 624 - 634nm G 525 - 530nm B 445 - 450nm Warm W - 2700K	R 624 - 634nm G 525 - 530nm B 445 - 450nm Amber - 1700K	Amber - 1700K Warm - 2700K Cool - 5700K	Custom single and multiple population
		Lumen output (All)	9556 lm	8240 lm	7748 lm	15092 lm	On enquiry
		Lumen maintainance	100,000 hours L70 at 50° C (Projected lifetime based on extrapolated LM-80 data)				
	Optics	Circular	10°	20°	40°	80°	Custom
Elliptical		10° x 60°	60° x 10°			On enquiry	
Body Finish	RAL Reference	 9005 Black	 9006 Silver	 9016 White		 CUSTOM	
	Finish	MN805L matt	SW262D matt	MA816E matt		On enquiry	
	Material	AkzoNobel polyester exterior grade powder coat					
Specifications	Electrical	Power input	120 - 277V AC @ 50/60Hz.				
		Wattage	240W.				
		Control	DMX 512 - 4 channels (VC) 3 channels (TW) Resolution - 8 bit (with intelligent smoothing) RDM - Remote Device Management for easy setup Thermal - Automatic Thermal Management built in.				
		Connection	Combined Power and DMX, provided on a QuickLINK+ connector.				
	Physical	Weight & Dimensions	23 kgs (50.7lbs) 443mm (H) x 420mm (W) x 230mm (D) (including yoke).				
		Material and finish	Cast LM6 aluminium, powder coated - corrosion pre-treatment as standard.				
		Mount options	Multi-purpose bracket.				
Lens and front glass		Acrylic lenses and toughened front glass to IK10.					
Temperature range		-20 to +50°C.					
Ingress protection	IP66 - Dry conditions and damp or wet interior/exterior environments.						
Accessories	Installation	Mounting plate	Installed as part of the first fix installation, allowing the rotation of the luminaire post installation.				
		Connection Kits	1m QuickLINK+ Cable	A 1 metre long QuickLINK+ cable, one end is bare to enable the connection to existing wiring.			
	* Not supplied. Please Specify the required connection kit for each luminaire.	IP Enclosure +1m QuickLINK+	An IP66 wiring enclosure with a 1m QuickLINK+ tail to plug into LuxEOS luminaires.				
		IP Enclosure +1m QuickLINK+ with QuickLINK Tails	An IP66 wiring enclosure with a 1m QuickLINK+ tail to plug into LuxEOS luminaires. This variant also has QuickLINK tails so that the luminaires can be daisy-chained together with a single cable run.				
		LuxCONNECT Wireless	A wireless DMX controller fitted within an IP65 enclosure. Controlled via the Casambi app.				
	Optical Control	Louvre	Individual baffles for each LED cluster to minimise glare.				
		Snoot	A baffle that fits around the luminaire to reduce off-axis glare.				
Half Snoot		A baffle that reduces off-axis glare from the top of the luminaire only.					

LuxEOS Flood 36 VIVID COLOUR & TUNABLE WHITE

LED FLOOD FOR ARCHITECTURAL LIGHTING

LuxEOS FLOOD - PART NUMBERS

OPTIONS	DESCRIPTION	PART NUMBER STRUCTURE							
		LSQU	XXX.	XXXX.	XX.	XXXX.	XXX.	XX.	XX
LSQU	LuxEOS luminaire	LSQU							
A09 / A18 / A36	Luminaire size - LuxEOS 9, 18, 36		XXX.						
RDM2	Control - DMX + RDM			XXXX.					
VC / A3 / A1 / TW	LED (VC=RGBW57K, A3=RGBW27K, A1=RGBW17K, TW=Tunable White)				XX.				
9005 / 9006 / 9016	Finish - 9005 (Black), 9006 (Silver), 9016 (White)					XXXX.			
010 / 015 / 020 / 030 / 040 / 060 / 080 H01 / V01 / H02 / V02 / H03 / V03	Beam angle - 10° (native) / 15° / 20° / 30° / 40° / 60° / 80° / H01 (10x60°) / V01 (60x10°) / H02 (15x60°) / V02 (60x15°) / H03 (30x60°) / V03 (60x30°)						XXX.		
not applicable								XX.	
not applicable									XX

Example : LuxEOS 36, RDM, VC 5700K, Silver, 40° = **LSQUA36.RDM2.VC.9006.040.XX.XX**

LUXEOS OPTICAL CONTROL ACCESSORIES - PART NUMBERS

OPTIONS	DESCRIPTION	PART NUMBER STRUCTURE							
		LUXI	XXX.	XXXX.	XX.	XXXX.	XXX.	XX.	XX
LUXI	LUXI accessory	LUXI							
A09 / A18 / A36	Luminaire - Luxeos 9, 18, 36		XXX.						
A001 / A002 / A003	Beam Shaper - A001 Louvre, A002 Snoot, A003 Half Snoot			XXXX.					
not applicable					XX.				
9005 / 9006 / 9016	Finish - 9005 (Black), 9006 (Silver), 9016 (White)					XXXX.			
not applicable							XXX.		
not applicable								XX.	
not applicable									XX

Example : LuxEOS 36 Louvre Black = **LUXIA36.A001.XX.9005.XXX.XX.XX**

INSTALLATION ACCESSORIES

Description	Part Number
Mounting plate for LuxEOS Flood 9 & 18, Beam 20 & 40	LUXIM01.F002.XX.9005.XXX.XX.XX
Mounting plate for LuxEOS Flood 36, Beam 80	LUXIM01.F001.XX.9005.XXX.XX.XX
QuickLINK+ cable 1m - bare ends	LUXIHWX.XL01.XX.NONE.XXX.XX.XX
QuickLINK+ cable 2m - bare ends	LUXIHWX.XL02.XX.NONE.XXX.XX.XX
QuickLINK+ cable 5m - bare ends	LUXIHWX.XL05.XX.NONE.XXX.XX.XX
LuxCONNECT box IP66 - With 1 - QuickLINK+ (F) 1m cable, for hardwired installation (supplied with cable glands)	LUXIHWX.WB01.XX.NONE.XXX.XX.XX
LuxCONNECT box IP66 - With 2 - QuickLINK+ (F) 1m cables, for hardwired installation (supplied with cable glands)	LUXIHWX.WB03.XX.NONE.XXX.XX.XX
LuxCONNECT Wireless connection box IP66 - With 1 - QuickLINK+ (F) 1m cable, for hardwired installation (supplied with cable glands)	LUXIHWX.LCW01.XX.NONE.XXX.XX.XX
LuxCONNECT Wireless connection box IP66 - Prewired with 2 - QuickLINK+ (F) 1m cable, 1 - for hardwired installation (supplied with cable glands)	LUXIQLX.LCW03.XX.NONE.XXX.XX.XX

LuxEOS Flood 36 VIVID COLOUR & TUNABLE WHITE

LED FLOOD FOR ARCHITECTURAL LIGHTING

PRODUCT DRAWINGS (All dimensions in mm)

Front view

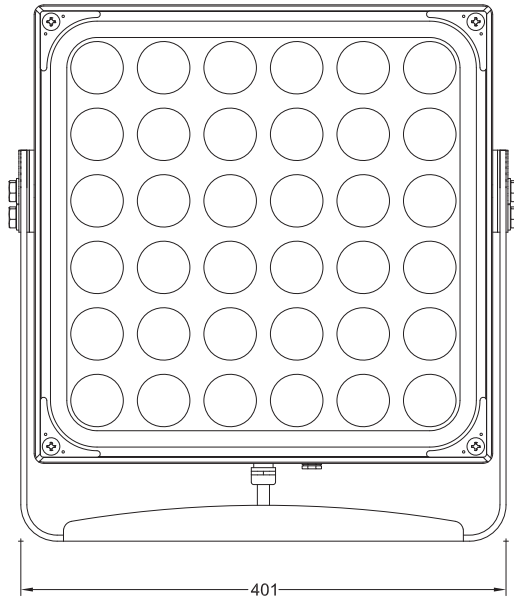

Side view

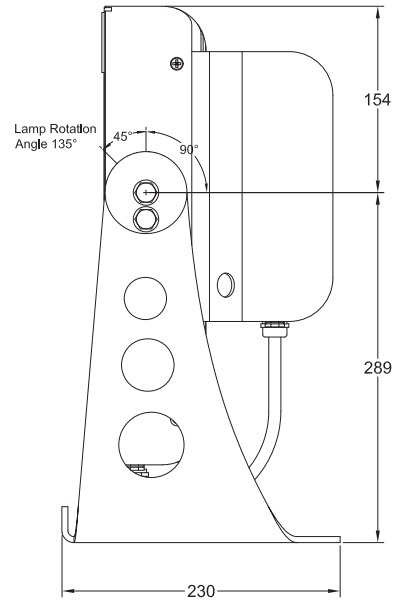

Rear view

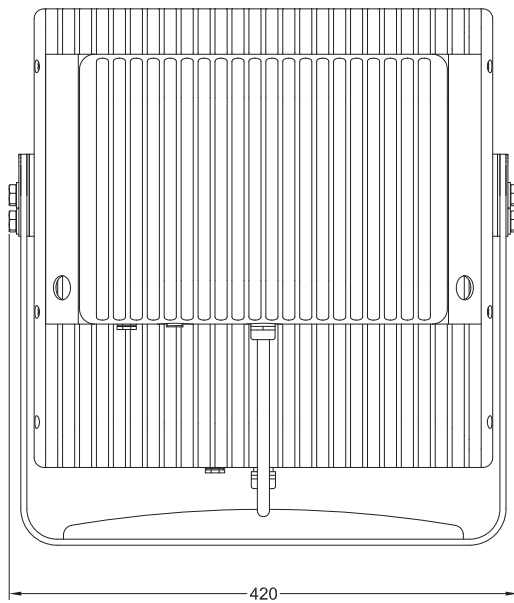

Perspective view

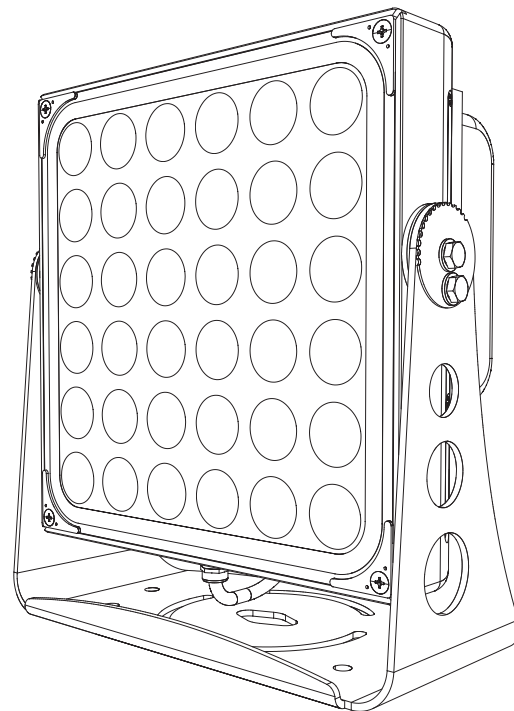

Top view

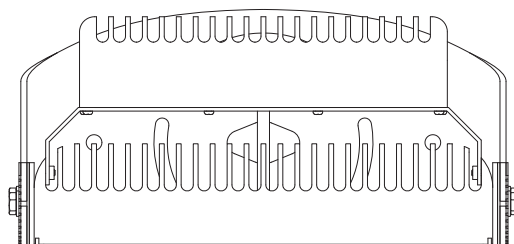

Weights

LuxEOS Flood 36 - 23 kgs

Dimensions

443mm (H) x 420mm (W) x 230mm (D)

LuxEOS Flood 36 VIVID COLOUR & TUNABLE WHITE

LED FLOOD FOR ARCHITECTURAL LIGHTING

PRODUCT DRAWINGS

Standard LuxEOS Flood 36
With optional Mounting Plate

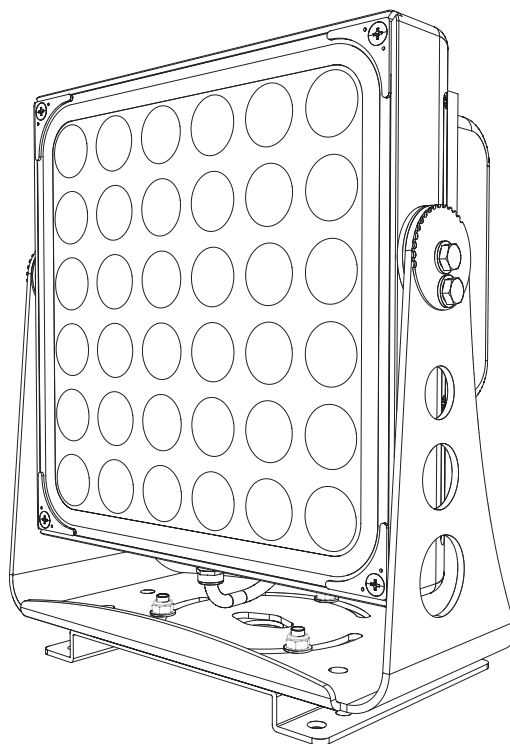

Standard LuxEOS Flood 36
With optional Mounting Plate
and 50mm Snout

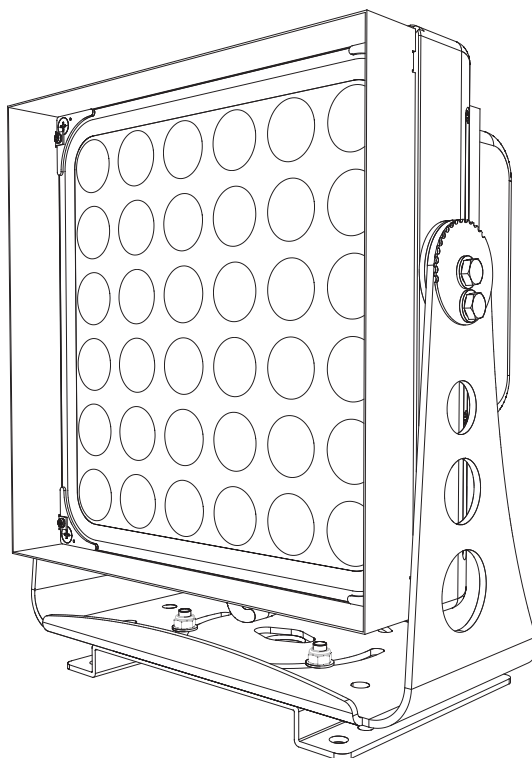

LuxEOS Flood 36 VIVID COLOUR & TUNABLE WHITE

LED FLOOD FOR ARCHITECTURAL LIGHTING

PRODUCT DRAWINGS

Standard LuxEOS Flood 36
With optional Mounting Plate
and Half Snout

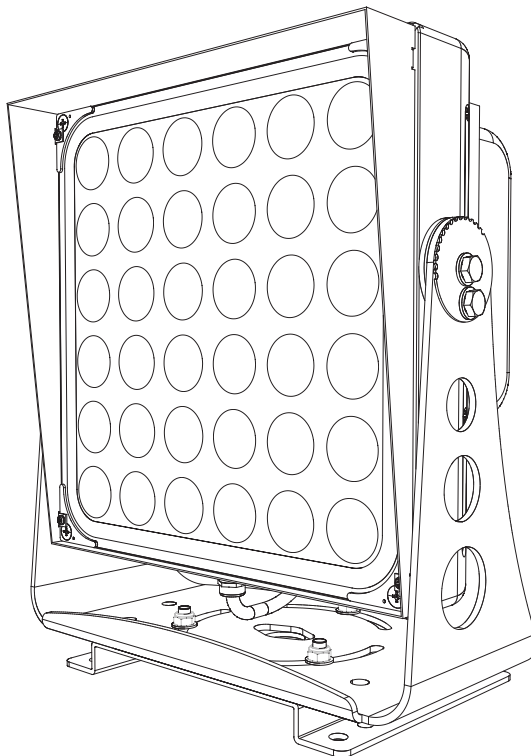

Standard LuxEOS Flood 36
With optional Mounting Plate
and Louvre

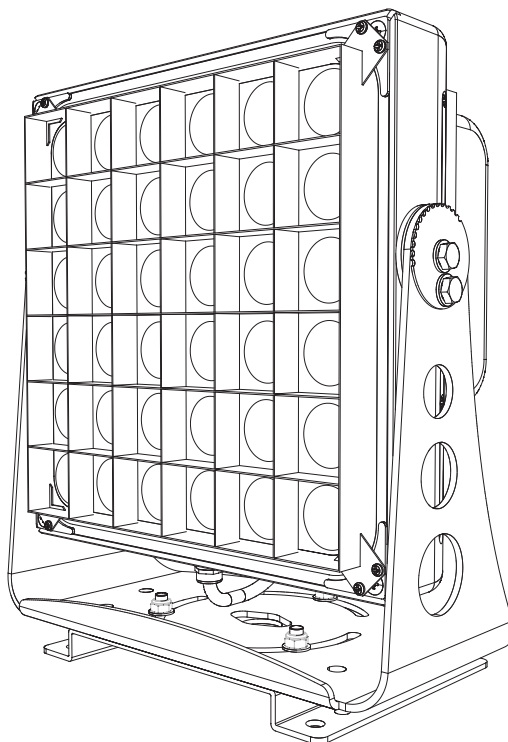















LuxEOS Flood 36 VIVID COLOUR & TUNABLE WHITE

LED FLOOD FOR ARCHITECTURAL LIGHTING

ADDITIONAL INFORMATION

Key Feature Icons

 Ingress Protection Value	 Mechanical Impact Protection IK Value	 Operating Temperature Range	 Corrosion Resistant
 Warranty Period	 Operating Voltage Range	 Smooth Interbit Theatrical Dimming	 True Flicker Free Output
 Colour Rendering Index Value	 Single Bin Led Selection	 DMX 512 Control	 RDM Compliant
 LuxRamp For Maximum Output	 Homogeneous Colour Mixing		

Cabling

Mains Supply Cable Colours (Harmonised)

Green/Yellow	Earth - Ground
Brown	Live Phase
Blue	Neutral

DMX Cable Colours (Pulsar)

White	DMX +
Blue	DMX -
Shield	Screen

QuickLINK+ Cable Colours (Power)

Green	Earth - Ground
Black	Live Phase
White	Neutral

QuickLINK+ Cable Colours (Data in)

White	DMX +
Green	DMX -
Shield	Screen

QuickLINK+ Cable Colours (Data through)

Red	DMX +
Blue	DMX -
Shield	Screen

Portable Appliance Testing

LuxEOS luminaires may be safely earth bond and insulation tested (500V).

Standards

LuxEOS luminaires comply with the following international and national harmonised standards

Electrical Safety - EN 60598, EN 60598-2-13, EN 61347
 EMC - EN 55015, EN 61547
 RoHS - EN 50581
 Photobiological – EN 62471
 WEEE - EN 50419
 Protection – IP66 / IK10

Warranty

Five years from the date of original purchase.

The warranty covers defects in manufacturing workmanship and materials. It is limited to parts and labour.

The warranty becomes void if the product is :-

- A Misused.
- B Not used in accordance with the instructions.
- C The cable connections are not made according to our instructions if the unit is used in damp or wet environments.
- D Repairs are made by unauthorised persons.
- E The serial number label has been removed or defaced.

Pulsar's maximum liability shall not exceed the price paid for the product.

In the unlikely event of a fault occurring, do not use without repair, return the product, with a description of the fault, to your supplier or direct to Pulsar for immediate attention.

Full warranty details are available on request or from our website at www.pulsarlight.com.

As part our commitment to continuous improvement PULSAR may change the specifications of its products without prior notification or public announcement.

All descriptions, illustrations, drawings and specifications in this publication present only general particulars and shall not form part of any contract.

Please visit our website for the most up to date information.

PULSAR

by DW Windsor Ltd, Pindar Road, Hoddesdon, Hertfordshire, EN11 0DX, UK
www.dwwindsor.com/pulsar | info@dwwindsor.com | +44 (0)1992 474600