

LIGHTSOFT



Indirect light-emitting bollard range with integrated solar panels. Smooth and sharp devised bollard family with digital controller and integrated battery enabling both mains and solar power supply.



Luminaire Structure

- Die-cast aluminium housing
- Extruded aluminium column
- Pre-treated before powder coating ensuring high corrosion resistance
- Stainless steel fasteners in grade 304 with zinc flake coating (ZFC)
- Durable silicone rubber gasket
- High-efficiency optical reflector or PMMA lens
- Clear UV-stabilised polycarbonate diffuser
- Anodised, high-purity aluminium reflector
- Integral control gear
- Solar panel mono-crystalline silicon high-efficiency 4x10W
- Lithium Iron Phosphate (LiFePO4) battery 16.5Ah 12 VDC
- Solar charger controller system 12V 10A

- Luminaires operation time depends on the weather conditions
- Full automatic electronic protection function against short circuit, overcurrent, overload, overvoltage and high temperature
- Standard: Off-grid, 100% solar, not connected to the utility grid. Utility grid connection is available upon request
- Without any sun (Autonomy), the battery would last for a maximum 5 days
- Motion sensor integrated
- Different dimming options are available
- STD: 2 Step dimming with motion sensor override (3 hours: 60% without movement, 100% for 1 minute when the motion sensor activated. After 3 hours: 30% without movement, 60% for 1 minute when the motion sensor activated)

- ND: Dusk to Dawn, CT: Custom examples are 5 Step dimming, Custom hours, Custom dimming levels (Step length and minimum dim level is 10%)
- Maximum 35.5 hours of operation time (2 Step dimming with motion sensor override)
- Remote solar charge controller can be ordered as an accessory
- Autonomy and Operation time calculations are done with the following information: Peak Sun-Hour (PSH) is 3 hours. Hours of operation are 12 hours per day. Detection of movement is 5 times per hour.
- Autonomy and Operation time calculations are only indicative and will depend on several variable factors. Please contact the factory to determine the specific calculations for your project.

Feature



Light symbol



T2 T3 T4 VW

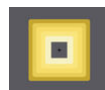

W

Product colour



01 - Black (RAL 9011) 02 - Dark Grey (RAL 7043) 03 - White (RAL 9003) 05 - Matt Silver (RAL 9006)



06 - Bronze (RAL 6014)

Special finishes upon request



SU01 - Concrete - Urban SU02 - Softscape - Urban SU03 - Stone - Urban SU04 - Corten - Urban

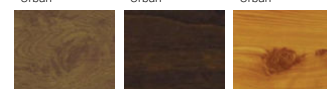

SW01 - Oak - Woodland SW02 - Walnut - Woodland SW03 - Pine - Woodland

We reserve the right to make technical and design changes.

01:46, 22-05-2023

<https://www.ligman.com/lightsoft-solar-integrated-bollards-light-s-bo3/>

THAILAND



LIGMAN Lighting Co.,Ltd.
17/2 Moo 4, Monthong, Bang Nam Priao,
24150 Chachoengsao - Thailand
info@ligman.com

LIGHTSOFT

Technical information

Model number	Light source	Power	Lumen	Optic	CCT / CRI	Dimming type	Weight	
186x186 mm - 1000 mm - 10.5 hours of operation time (2 Step dimming with motion sensor override) - 5 days of autonomy								
LIGHTSOFT 20	LH-10823	18 LED	6 W	528 lm	T2 [136°x22°], T3 [140°x44°], T4 [148°x78°], VW [120°], W [108°]	3000K CRI80, 4000K CRI80	Solar Custom, Dusk to Dawn, 2 Step dimming with motion sensor override	19 kg
186x186 mm - 1000 mm - 17.5 hours of operation time (2 Step dimming with motion sensor override) - 5 days of autonomy								
LIGHTSOFT 20	LH-10822	18 LED	4 W	352 lm	T2 [136°x22°], T3 [140°x44°], T4 [148°x78°], VW [120°], W [108°]	3000K CRI80, 4000K CRI80	Solar Custom, Dusk to Dawn, 2 Step dimming with motion sensor override	19 kg
186x186 mm - 1000 mm - 35.5 hours of operation time (2 Step dimming with motion sensor override) - 5.5 days of autonomy								
LIGHTSOFT 20	LH-10821	18 LED	2 W	176 lm	T2 [136°x22°], T3 [140°x44°], T4 [148°x78°], VW [120°], W [108°]	3000K CRI80, 4000K CRI80	Solar Custom, Dusk to Dawn, 2 Step dimming with motion sensor override	19 kg

Accessories

	
Anchor bolt A10391	Remote solar charge controller for Solar Integrated Bollards and Vertical Solar PV poles A92691
LH-10821	•
LH-10822	•
LH-10823	•

LIGHTSOFT

Adjustable sensor (10 - 150 seconds)
360° sensitivity
Sensor detection area: 7 - 10 m

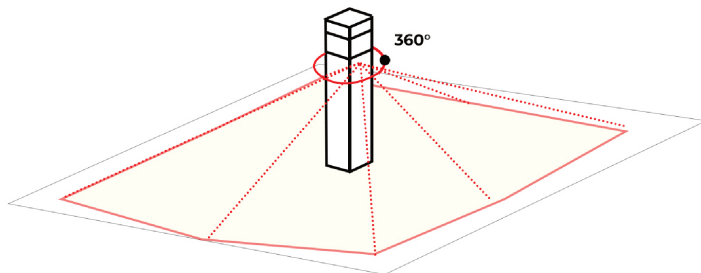

LIGHTSOFT 20

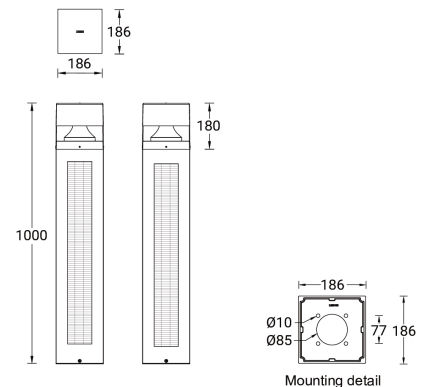

LIGHTSOFT

LIGHTSOFT
Surface facade luminaires

Surface wall-mounted wall decorative family. Hidden-source, perfectly glare free contemporary ambient lighting fixtures.

<https://www.ligman.com/lightsoft-surface-facade-luminaires-lig-su3/>

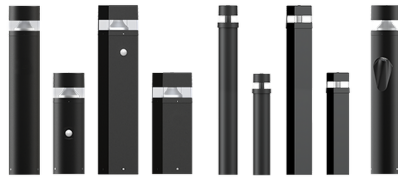

LIGHTSOFT
Bollards

Indirect light-emitting bollard range. Smooth and sharp devised bollard family with wonderful soft controlled lighting options.

<https://www.ligman.com/lightsoft-bollards-lights-bo3/>